

CHARACTERISTICS		
Nominal Voltage		12V
Nominal Capacity (20 hour rate)		70Ah
Capacity 25°C	10 hour rate (9.0A)	63Ah
	5 hour rate (15.9A)	55.5Ah
	1 hour rate (55.4A)	38.8Ah
Internal Resistance		Full Charged Battery 25°C ≤7mΩ
Capacity affected by Temperature (10 hour)	40°C	102%
	25°C	100%
	0°C	85%
	-15°C	65%
Self-Discharge 25°C Capacity	after 3 month storage	90%
	after 6 month storage	80%
	after 12 month storage	62%
Charge (Constant Voltage) 25°C	Float	Initial Charging Current Less than 14A Voltage 13.6-13.8V
	Cycle	Initial Charging Current Less than 14A Voltage 14.4-14.9V

PACKAGING		
Battery Dimensions	Length	350mm
	Width	167mm
	Height	178mm
	Total Height	178mm
Box Dimensions	Length	365mm
	Width	181mm
	Height	224mm
Quantity Per Box	1 PC per box	
Net weight Per Cell	23.3 kg±3%	
Net weight Per Box	23.3kg	
Gross Weight	23.8kg	

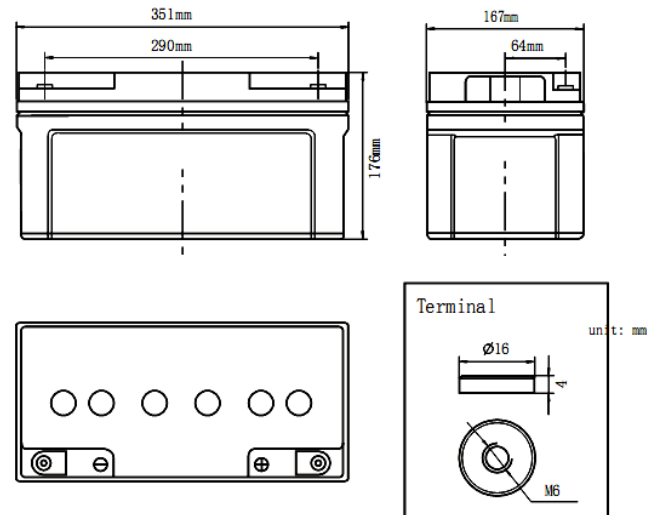

Discharge Constant Current per Cell (Amperes at 25°C)

F.V/Time	5min	10min	15min	30min	45min	1h	2h	3h	5h	8h	10h	20h
1.60V	166.3	106.0	90.1	57.5	42.3	38.8	24.7	17.3	11.8	7.8	6.9	3.85
1.65V	163.3	104.1	88.5	56.5	41.5	38.1	24.2	17.0	11.6	7.6	6.8	3.78
1.70V	160.3	102.2	86.8	55.4	40.7	37.4	23.8	16.7	11.4	7.5	6.7	3.71
1.75V	157.2	100.2	85.2	54.4	40.0	36.7	23.3	16.4	11.1	7.3	6.6	3.64
1.80V	151.2	96.4	81.9	52.3	38.4	35.3	22.4	15.8	10.7	7.1	6.3	3.50

Discharge Constant Current per Cell (Watts at 25°C)

F.V/Time	5min	10min	15min	30min	45min	1h	2h	3h	5h	8h	10h	20h
1.60V	320.2	204.1	173.4	110.7	81.4	74.7	47.5	33.4	22.7	14.9	13.3	7.4
1.65V	314.3	200.4	170.3	108.7	79.9	73.3	46.6	32.7	22.3	14.7	13.1	7.3
1.70V	308.5	196.7	167.1	106.7	78.4	72.0	45.8	32.1	21.9	14.4	12.9	7.1
1.75V	302.7	193.0	164.0	104.7	76.9	70.6	44.9	31.5	21.4	14.1	12.6	7.0
1.80V	291.1	185.6	157.7	100.7	74.0	67.9	43.2	30.3	20.6	13.6	12.1	6.7

Note: The above data are average values, and can be obtained within 3 charge/discharge cycles. These are not minimum values. Cell and battery designs/specifications are subject to modification without notice. Contact R&J for the latest information.

PERFORMANCE CHARACTERISTICS

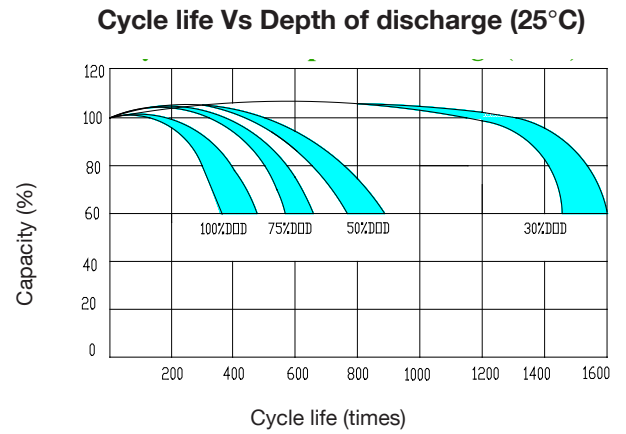
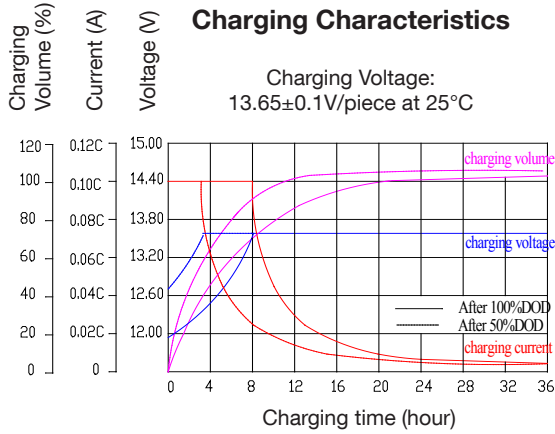

Temperature effect on designed float life

Float charging Voltage: 13.65±0.01V/piece at 25°C

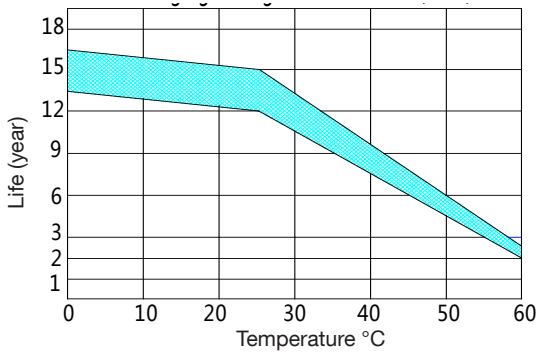

Discharge characteristics (25°C)

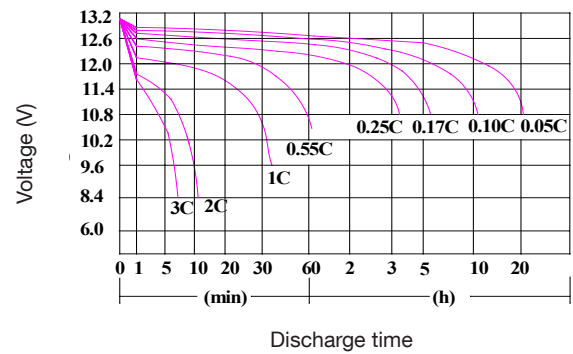

Temperature effect on battery self-discharge

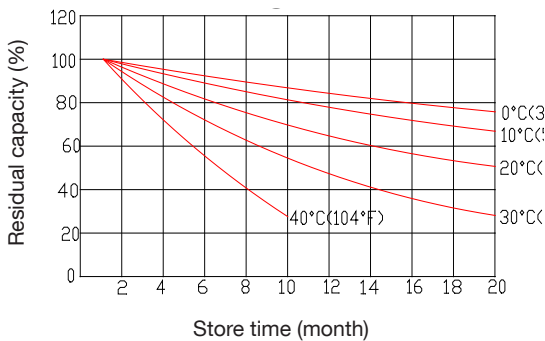

Temperature effect on capacity

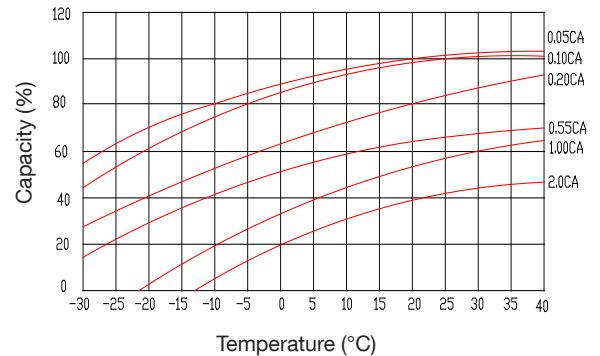

BATTERY CONSTRUCTION

Component	Positive plate	Negative plate	Container	Cover	Safety valve	Terminal	Separator	Electrolyte
Raw material	Lead dioxide	Lead	ABS	ABS	Si-Rubber	Copper	Fiberglass	Sulfuric acid