

The REDMAX MT-105M-20W is a high efficiency monocrystalline solar panel with 3.2mm tempered glass on the front face and a durable anodized aluminium alloy frame.

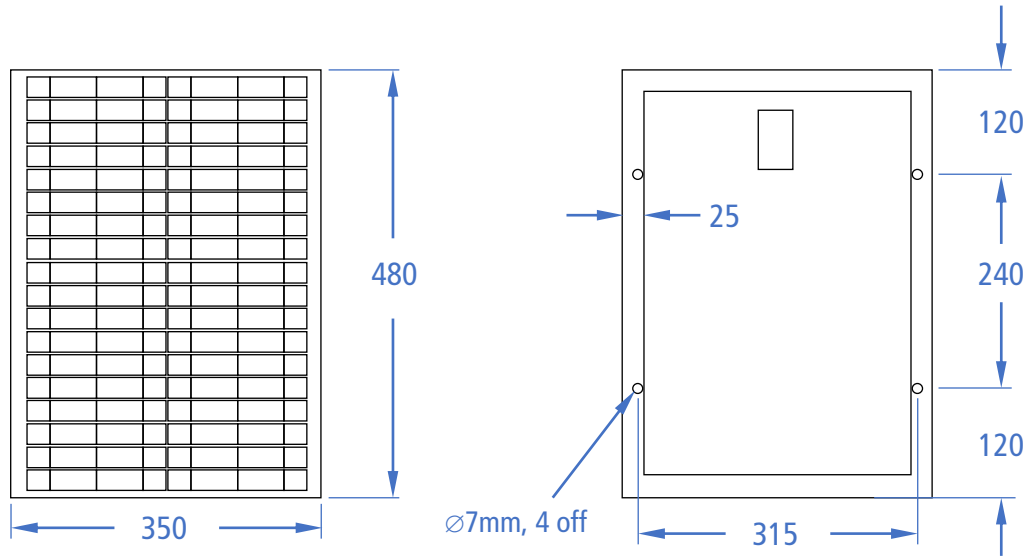

TECHNICAL SPECIFICATIONS

Maximum Power, P_m	20W	Dimensions (LxWxH)	480 x 350 x 25mm
Maximum Power Voltage, V_m	18.0V	Weight	2.0kg
Maximum Power Current, I_m	1.11A	Front Glass	3.2mm Tempered Glass
Open Circuit Voltage, V_{oc}	22.5V	Hail Load Test	Steel ball drop from 1m
Short Circuit Current, I_{sc}	1.36A	Frame	Anodised Aluminium Alloy
Cell Efficiency	18.5%	Junction Box Type	IP65 rated
Fill Factor, FF	$\geq 74\%$	Temp. Coeff. @ V_{oc}	-0.24% to -0.33% / °C
Working Temperature	-40°C to +85°C	Temp. Coeff. @ P_m	-0.37% to -0.42% / °C
Power Tolerance	$\pm 5\%$	Temp. Coeff. @ I_{sc}	-0.03% to -0.04% / °C